

STREETFIGHTER V4



Index

5	The Fight Formula	32	The Time Fighter
8	Design: Joker face	39	The Streetfighter V4 SP engine
10	The Fight Formula in Black	40	Chassis for the Streetfighter V4 SP
12	Racing-derived aerodynamics	44	Servicing and maintenance
15	Ergonomics: greater control and comfort	47	Technical data and equipment
17	An extraordinarily powerful engine	58	Accessories Configure the Ducati of your dreams.
19	MotoGP-derived chassis	66	Apparel
22	Riding Mode strategy	72	Ducati Digital Experience
24	Latest-generation TFT instrumentation		
27	Electronics package: all under control		





The Fight Formula

The Panigale V4, stripped of its fairings, with a high, wide handlebar, 178 kg weight, and 208 hp 1100 cc Desmosedici Stradale engine, kept at bay with biplane wings and a latest-generation electronics package: this is the “Fight Formula” for the Streetfighter V4.

The result is an unrivalled naked bristling with cutting-edge technology that does nothing to hide its big bad character from those who fearlessly take on new challenges.

As streetfighter culture dictates, the Front Frame and Desmosedici Stradale engine remain as visible as possible, the superstructures reduced to a minimum for a clean, pared back look. Tracing the dynamic lines of the tank, the low, protruding front section gives the Streetfighter V4 added strength and character.

The 1103 cc Desmosedici Stradale of the Streetfighter V4 generates 208 hp, impressive power for a naked that can in fact reach 220 hp with the full-racing Ducati Performance by Akrapovič exhaust.

Designed in collaboration with Ducati Corse, the biplane wings generate the necessary downforce to ensure maximum stability during all riding phases, particularly at high speeds, and quick and agile handling through mixed sections. Also contributing to bike control is the electronics package, derived from the Panigale V4 and based on the use of a 6-axis IMU that can instantaneously identify the bike’s roll, yaw and pitch angle in space.

The electronics package includes controls to manage all riding phases, from the start, to acceleration, braking, traction, through the corners and out the other side. The controls can be adjusted by the rider and combined with the available Race, Sport and Street Riding Modes.

The 2022 range will include the latest version of the SP, a bike that is even more effective on both road and track.

At first glance, what differentiates the Streetfighter V4 SP from the Streetfighter V4 is its specific livery and visible brushed aluminium tank, as well as the bright red details that stand out on the matte black super structures and on the matte carbon finish of the rims and wings.

The Streetfighter V4 is available in the standard and S versions. Both versions are available in the Ducati Red colour with Dark Grey frame and black wheels. The S version is available in the new Dark Stealth colour too.



Design: Joker face

The minimalist full LED headlight perfectly captures the spirit of the Streetfighter V4. Though reminiscent of the front end of the Panigale V4, it also resembles the crazy grin of the Joker, the comic book character who inspired the designer responsible for creating the new Borgo Panigale naked in the Ducati Style Center.

The full LED headlight assembly, part of the dual layer fairing, has a particular design that allows it to incorporate the air-box and LED cooling vents, while a rear deflector prevents flow from impacting directly on the tank. The headlight is surmounted by a 5" TFT display, the same as that of the Panigale V4, complete with sophisticated front cover that elegantly conceals attachments and wiring.



The Front Frame and Desmosedici Stradale engine are only partially covered by superstructures that are reduced to a minimum, their lines sharp and volumes sculpted. Behind the radiator are the hot air extractor rims, inspired by the world of F1 cars. These have a structural function, are attached directly to the frame, and integrate the MotoGP-derived overlapping double wings that generate the necessary downforce to ensure maximum stability.



The Fight Formula in Black

The Dark Stealth colour scheme which makes the look of the bike even more thrilling.

Dark Stealth is electrifying, trendy, aggressive, the perfect colour scheme to flaunt the "badass" side of the Streetfighter V4 S and attract attention when riding it.



AERODYNAMICS

Racing-derived aerodynamics

Fast, agile mixed-road performance demands maximum stability at high speed and when braking, reduced wheel-up during acceleration and minimised electronic control of the suspension set-up: that's why Ducati Corse specialists have, together with the Ducati Style Centre, developed biplane wings for the Streetfighter V4.

The aerodynamics were entirely developed using CFD (Computational Fluid Dynamics) simulation. The calculation method involves stationary simulation of flow and pressure to achieve increased downforce, especially on the front wheel.

To reduce lateral protrusion as much as possible, the aerodynamics team decided to adopt a 'biplane' configuration of limited wingspan with upper and lower wings working independently. Each appendage can be described as a square-plan mono-wing with a winglet on its outer tip. Moreover, the wings have been positioned as close as possible to the front wheel (near the radiator side panels) to maximise the anti wheel-up effect.

These aerodynamic appendages generate 28 kg of downforce at 270 kph (20 kg on the front wheel, 8 kg on the rear). The wings also help draw heat off the engine by increasing water and oil radiator throughflow speeds by 2% and 10% respectively. Wing-generated downforce reduces front wheel 'floating' at high speed and the tendency to wheel-up. It also improves stability during braking, corner entry, and through the corner.

The aerodynamics thus instil confidence and limit intervention of the electronic controls. This helps the rider keep the throttle open longer and brake later going into the bends, resulting in significant performance benefits.



ERGONOMICS

Ergonomics: greater control and comfort

With respect to the Panigale V4, the rider's seat position, 845 mm from the ground, has been redefined according to the specifications of a naked model.

The semi-handlebar has been replaced with a high, wide bar that, together with a less extreme rider footpeg position, guarantees sports comfort during inner city rides as well as the control needed when taking on country roads or the racetrack. The lower part of the tank has been modified to allow for the mounting of a seat with extra foam, to further increase rider comfort.

In addition, the tail has been redesigned. Supported by a steel subframe, it retains many of the style features of the Panigale while also offering the passenger greater comfort and the rider more room lengthways.





ENGINE

An extraordinarily powerful engine

The Streetfighter V4 is powered by the Euro 5*, 1103 cc Desmosedici Stradale, that delivers 153 kW (208 hp) @ 13,000 rpm* and maximum torque of 123 Nm (90.4 lb-ft) @ 9,500 rpm*. Power can be raised to 220 hp by fitting the full-racing Ducati Performance exhaust by Akrapovič that also reduces weight by 6 kg.

The Desmosedici Stradale was designed around the core of the V4 MotoGP engine and has the same dimensions and geometry, as well as the same general configuration, a 90° V4 rotated rearward by 42°.

The crankshaft is counter-rotating to reduce the gyroscopic effect of the wheels and improve handling and agility when changing direction, as well as reduce the tendency to wheel-up during acceleration or lift during sharp braking. In addition, 70° offset of the crank pins results in a "Twin Pulse" type firing order that, as well as making for an unmistakable sound, also ensures

easy to manage delivery and excellent traction out of the turns.

"Box in box" aluminium moulded pistons churn in the barrels of the cylinders, with two piston rings, low friction, plus 81 mm oil scraper ring, the same as the MotoGP Desmosedici engine. The 53.5 mm stroke brings the total engine size to 1103 cc. The compression ratio is 14:1, a significant value indicative of the racing-derived design.

The engine's "Desmo" type distribution is technically perfect and achieves a level of sophistication, compactness and lightness never before seen on a Ducati bike. The four camshafts drive the sixteen steel valves. Intake valves are 34 mm in diameter, exhaust valves 27.5 mm, remarkable values in relation to the 81 mm bore.

Air intake is entrusted to four oval throttle bodies (52 mm diameter equivalent) connected to fixed 70 mm long intake horns.

Each throttle body has two injectors and is activated by a dedicated electric motor that, thanks to the full Ride by Wire system, allows for complex electronic control strategies and modulation of engine 'feel' according to the selected riding mode.

With the Desmosedici Stradale, valve play adjustment is required every 24,000 km, while a service should be carried out every 12,000 Km/12 months.

* Only for countries where Euro 5 standard applies.

CHASSIS

MotoGP-derived chassis

Front-Frame

The Streetfighter V4 features the Panigale V4 Front-Frame, an offshoot of Ducati's extensive experience in MotoGP, which uses the engine as a load-bearing member.

Weighing just 4 kg, the compact Front-Frame is attached directly to the upper crankcase of the front cylinder bank and the cylinder head of the rear bank; the V4 crankcase also provides the rear suspension attachment point and the single-sided swingarm pivot mount. The main advantage of this solution is that it uses the engine to achieve the desired stiffness, which has resulted in significantly lower main frame length and a better stiffness/weight ratio.

Completing the chassis is the under-seat trellis subframe, attached to the Front-Frame at the top and bolted to the head of the rear cylinder bank below. The rear suspension linkage mechanism is attached to the Desmosedici Stradale

engine via a forged aluminium bracket. The linkage reacts to movements imparted by a cast aluminium high-truss single-sided swingarm, the distance between the swingarm fulcrum and rear wheel axle 16 mm greater than that of the Panigale, guaranteeing, together with the biplane wings, maximum stability during all riding phases, particularly at high speeds.

The steering geometry features 24.5° rake and 100 mm trail.

Sophisticated suspension

The Streetfighter V4 mounts a 43 mm Showa Big Piston Fork (BPF) that is fully adjustable in terms of spring pre-load, compression and rebound damping. The fork bodies accommodate chrome stanchions, attached to which are the Brembo radial callipers. A Sachs steering damper completes the front-end package.





At the rear is a fully adjustable Sachs shock absorber, one side of which is attached to the Desmosedici Stradale engine via a forged aluminium bracket. The S version is equipped with the Ducati Electronic Suspension EVO system, complete with Öhlins NIX-30 fork, an Öhlins TTX36 rear shock absorber and an Öhlins steering damper with Smart EC 2.0 control system.

Wheels and tyres

While the standard Streetfighter V4 mounts cast aluminium 5-spoke wheels, the V4 S is equipped with 3-spoke Marchesini forged aluminium alloy wheels.

The rims mount Pirelli Diablo Rosso Corsa II tyres. Combining track performance with road versatility, they come in the 120/70 ZR17 (front) and 200/60 ZR 17 (rear) sizes, already used extensively for slick tyres in the FIM Superbike World Championship. The rear tyre compound has been

designed by Pirelli specifically for the Streetfighter V4. It ensures the same dynamic behaviour as the Supercorsa SP race replica tyres mounted on the Panigale V4 but offers better performance in low temperatures to ensure the versatility required of a naked model.

Braking system with Brembo Stylema® callipers

The Streetfighter V4 range features powerful Brembo Stylema® monobloc callipers, the successor to the already high performance M50 callipers.

The Stylema® callipers, created from a single alloy block, are visibly more compact with respect to the M50 type, allowing for a 70 g weight reduction per calliper, with no loss of rigidity. Other developments have been made in terms of internal ventilation to ensure more consistent performance. The dual Brembo callipers each mount four 30 mm pistons that act on 330 mm

discs to guarantee exceptional braking power. At the rear is a single 245 mm disc with 2-piston calliper.

Streetfighter V4 models are fitted with new front brake and clutch pumps, both self-bleeding. The body of the pumps has been designed with a configuration that allows a 'natural' bleeding, thus eliminating the need to intervene on the system in the event of air present in the circuit.

Racing tank

As on race bikes, the 16-litre aluminium tank has a section that extends under the rider's seat. With respect to the Panigale V4, the lower section of the tank has been modified to allow installation of a seat with thicker padding to boost rider comfort.



Riding Mode strategy

Riding Modes provide users with three different pre-set riding styles so that Streetfighter V4 performance can be adapted to the rider, road type and weather conditions. Changing the Riding Modes instantaneously changes the character of the engine, the electronic control parameters and, on the S version, the suspension set-up. Riders can personalise settings to suit their riding style or restore the default parameters. They can also enable ABS Level 1 (intended for on-track use by expert riders) which acts on the front wheel only to allow maximum braking performance.

Race Riding Mode.

This Riding Mode allows riders, including those who are less expert, to enjoy excellent performance on high-grip track surfaces. The rider can count on 208 hp, with direct Ride by Wire throttle response and, on the S version, a firm suspension set-up to optimise performance. Race mode sets the electronics at a low intervention level but without lowering safety, with ABS set to level 2, lift-

up control off and the 'slide by brake' function on (allowing riders to drift the bike into corners safely).

Sport Riding Mode.

Selecting Sport gives the rider 208 hp, with direct sports-style Ride by Wire throttle response and, on the S version, a sports-style suspension set-up. Electronic controls are set to give riders perfect dry road ride responsiveness. Rear wheel lift detection during braking is on and the ABS Cornering function is set to maximise cornering performance.

Street Riding Mode.

Street mode is recommended when riding on surfaces with poor grip. This Riding Mode gives the rider 208 hp and progressive Ride by Wire throttle response (as with the Sport RM) and, on the S version, a suspension set-up that is well suited to bumpy or pitted roads. Electronic control settings ensure grip and stability to maximise safety.

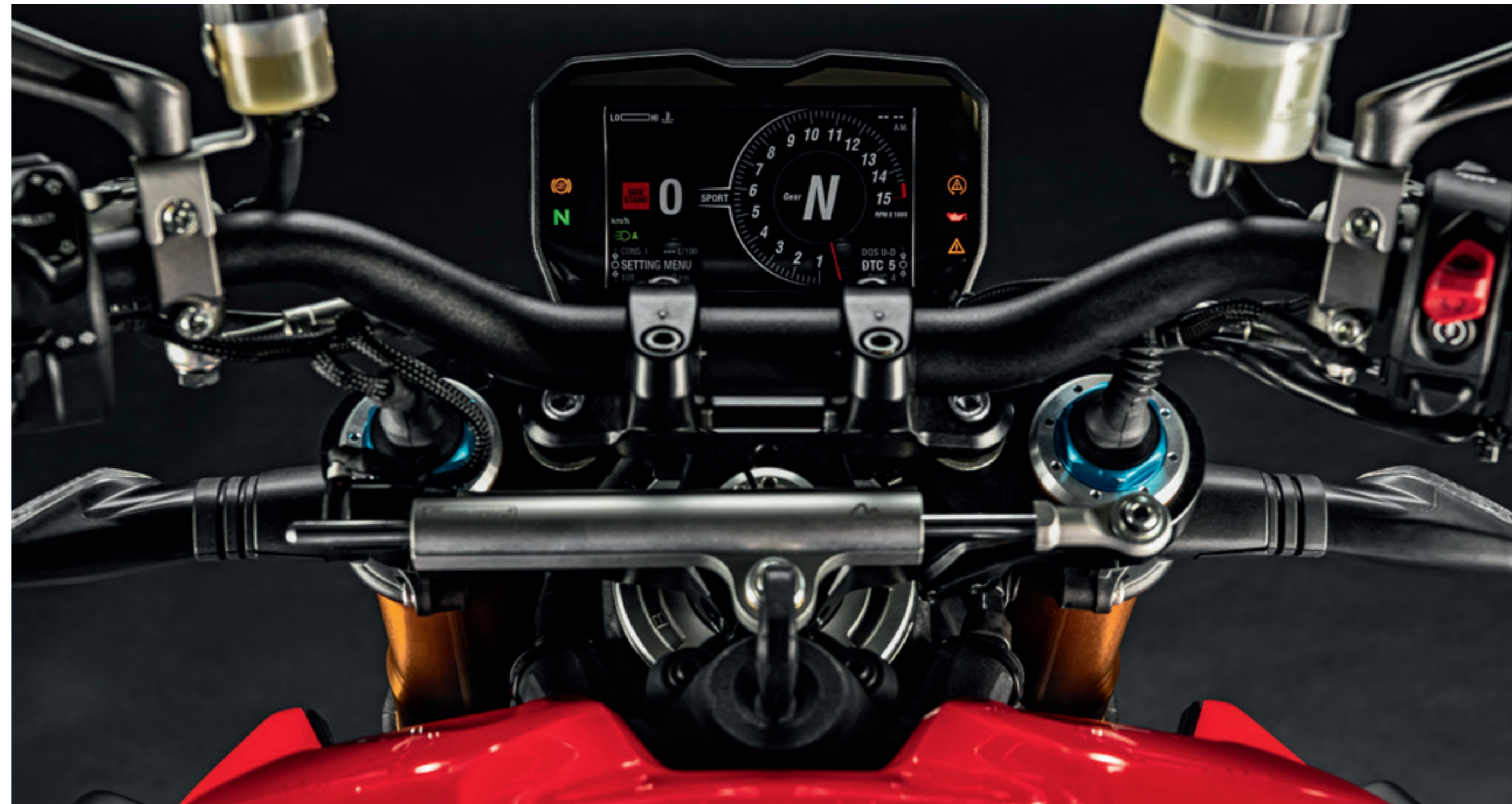

Latest-generation TFT instrumentation

The Streetfighter V4 features the same 5" TFT colour display as the Panigale V4. The dashboard is dominated by the rev counter that displays engine performance with a needle gauge. Movement of the gauge is accompanied by a white trail that acts as a 'shift light', changing colour from white to orange and then red as the rev limit approaches. The rider can call up two different layouts: 'Track' highlights the lap times, while 'Road' replaces lap times with data relating to the Ducati Multimedia System that, where present, offers a rev scale more appropriate for road use.

Ducati Lap Timer GPS

The Ducati Lap Timer GPS automatically records and saves lap times and displays them directly on the dashboard each time the bike crosses the finish line, the coordinates of which are set by pressing the flasher button. If a lap time is the best of the current track session, the Best Lap function causes it to flash for 5 seconds. On each lap, and for a total of 15 consecutive laps, DLT GPS records

lap time, maximum rpm and maximum speed. This data can be called up from the relevant menu. DLT GPS is available as a Ducati Performance plug-and-play accessory

Ducati Data Analyser + GPS

The Ducati Data Analyser + GPS allows assessment of bike and rider performance by showing traces for specific data items. Not only does it automatically display and record Streetfighter V4 lap times every time the bike crosses the line, it also saves other data traces such as throttle opening, bike speed, engine rpm, selected gear, engine temperature and distance travelled. The Ducati Data Analyser is available as a Ducati Performance plug-and-play accessory.

Ducati Multimedia System

The Streetfighter V4 is suitable for use with the Ducati Multimedia System. This lets riders take incoming calls, select and listen to music tracks or receive text messages via a Bluetooth link. When the rider climbs aboard, the smartphone



automatically connects to the bike via Bluetooth, letting the rider control the main multimedia functions. The TFT display shows the track being played, the new text message icon or the caller's name. DMS is available as a Ducati Performance plug-and-play accessory.



ELECTRONICS

Electronics package: all under control

The latest-generation electronics package on the Streetfighter V4 is based on a 6-axis Inertial Measurement Unit complete with controls to manage every riding phase. In addition, the operating parameters of each control are associated by default with the three Riding Modes. Riders can therefore personalise their riding style or restore the factory settings. Any of the control levels can be quickly adjusted via the left switchgear.

ABS Cornering Bosch

The Bosch ABS system features the cornering function, which keeps the ABS working even with the bike leaned over. It can be set at three different levels to fully satisfy the needs of all riders, on racetrack or road, even in critical situations of low grip. Level 3 is recommended for road riding or anywhere with poor grip, as it ensures safe and stable braking in all conditions, while levels 2 and 1 prioritise braking power and are intended for use on high-grip surfaces or racetracks.

Ducati Traction Control (DTC) EVO 2

The new Ducati Traction Control EVO 2 (DTC EVO 2) strategy is an offshoot of the Ducati Desmosedici GP18. In addition to interfacing with the 6-axis IMU and adapting intervention based on wheelspin and lean angle, the software significantly improves corner exit power control thanks to a new 'predictive' strategy. Acting not just on the basis of instantaneous rear wheelspin but also its variation, it intercepts any loss of grip sooner and reduces peak wheelspin, ensuring faster, smoother intervention. All this means increased corner exit stability (even in sub-optimal grip conditions), greater acceleration and improved performance over both a flying lap and long run. In addition to controlling spark advance and injection, the DTC EVO 2 system uses the throttle body valves to maintain optimal combustion parameters and ensure more fluid engine response and control, in all situations where rapid intervention is not required.

Ducati Slide Control (DSC)

The introduction of the 6D IMU has allowed Ducati Slide Control (DSC) - developed in collaboration with Ducati Corse - to be added to Ducati Traction Control EVO. This system assists riders by controlling the torque delivered by the engine based on the slide angle. Its purpose is to improve corner exit performance by preventing slide angles that would otherwise be difficult to handle. The DSC relies on the 6D IMU that provides the vehicle control unit with crucial information about bike dynamics, such as lean angle, acceleration and much more.

Ducati Wheelie Control (DWC) EVO

The Streetfighter V4 also comes with the latest version of Ducati Wheelie Control EVO (DWC EVO). Using the data feed from the Bosch 6D IMU, this system keeps wheel-up in check while maximising acceleration easily and safely. DWC EVO provides more accurate wheel-up readings and therefore exerts more precise control to ensure the bike responds faster to rider input.

Ducati Power Launch (DPL)

This system ensures lightning-fast starts, letting the rider focus solely on releasing the clutch. Once set to one of the three available levels (level 1 favours high-performance starts, level 3 is safe and stable), the rider need only engage first gear and open the throttle. During the initial moving-off stage, as the rider modulates clutch release, DPL stabilises the engine at optimal revs. During the second stage, when the clutch has been fully released, DPL controls torque

delivery to maximise acceleration.

Ducati Quick Shift up/down (DQS) EVO 2

The Ducati Quick Shift EVO 2 with up/down function uses lean angle data to maximise bike stability when changing gear through a bend. DQS EVO 2 allows for clutch-less downshifting. Thanks to full Ride-by-Wire control, the system works differently for up- and downshifting, integrating spark advance and injection adjustment during upshifts with an auto-blipper function during downshifts. In addition, during downshifts, DQS EVO 2 works in concert with the anti-patter clutch and Engine Brake Control.

The EVO 2 software, derived from the Panigale V4 R, reduces upshift times, allowing the sportier high-rev gear shifts (over 10,000 rpm) typical of track riding and boosting shift stability during aggressive acceleration and cornering.



Engine Brake Control (EBC) EVO

The Engine Brake Control was developed to help riders optimise bike stability under extreme turn-in conditions and does so by balancing the forces applied to the rear tyre under severe engine braking conditions. The Streetfighter V4 EBC EVO system, optimised according to lean angle, monitors the throttle body valve position, selected gear and crankshaft deceleration during aggressive braking and adjusts throttle aperture to balance out the torque forces applied to the tyre. EBC EVO has three different settings, integrated into the Riding Modes.

**Ducati Electronic Suspension (DES) EVO**

The "S" version is equipped with electronically controlled suspension based on the second-generation Öhlins Smart EC (Electronic Control) system that, as well as exploiting the potential offered by the 6-axis IMU, also has a new and more intuitive settings interface. It offers a choice of two modes: Fixed, to manually set compression and rebound levels and steering damping (32 from fully open to fully closed for the suspension, and 10 for the damper), and Dynamic, the system automatically regulating compression and rebound damping to suit the riding style, based on data received from the 6-axis IMU and other sensors.

The Time Fighter

Introducing the top-of-the-range Streetfighter V4 SP model. The most adrenaline-pumping naked to ever roll its wheels off the production line in Borgo Panigale, it boasts exclusive technical equipment that combines the "Fight Formula" with "SP" specifications, further boosting the power/weight ratio of the Streetfighter V4 S, which was already the best in category, and making the bike even more effective on both road and track.

Aesthetically, the SP stands out thanks to its "Winter Test" livery, which Centro Stile Ducati created by taking inspiration from the bikes used during MotoGP and SBK pre-season testing. The new carbon rims, 1.4 kg lighter than those of the Streetfighter V4 S, significantly reduce the moment of inertia and contribute to an overall weight saving of 3 kg. The 1103 cc Desmosedici Stradale engine features a counter-rotating crankshaft, "Twin Pulse" firing order, 208 HP of power and 123 Nm of torque at 9500 rpm. The

STM-EVO SBK dry clutch ensures a more effective anti-hopping function but also reproduces the characteristic sound that Ducatisti so appreciate. The comprehensive range of equipment is completed with Ohlins Smart EC 2.0 suspension and the Brembo Stylema R[®] braking system with front callipers.



Designed for those who want to rule the track.

Thanks to its technical equipment, the Streetfighter V4 SP is the ideal companion for the amateur who wants to rule the track with a naked bike and get an instant response. Boasting extraordinary braking power, the bike is easier to lay into the corner and reaches the apex quicker, while also ensuring excellent stability at high speeds.

Carbon Fibre Rims*

The premium-quality split five-spoke rims are made of high-strength carbon fibre and feature aluminium hubs that are screwed to the composite structure. 1.4 kg lighter than the forged aluminium rims of the Streetfighter V4 S, this solution contributes to an overall weight saving of 3.4 kg. The result? A significant reduction in the moment of inertia, which makes for greater agility and lightness when changing direction.

Braking system*

The braking system consists of two 330 mm Brembo front discs combined with new Brembo Stylema® R monobloc callipers, featuring racing-derived pistons equipped with ventilation holes. This solution improves the stability of the lever stroke even after many laps of the track, and further reduces residual torque.

*Bike specifications and equipment may vary from market to market. Please refer to your local dealer for further information



Anodized aluminium footpegs.

The rider footpegs are in high-quality anodized aluminium alloy, which maintains its original appearance over time. These attractive elements allow the rider to find the position that best suits their riding style. Carbon fibre heel guards and brake and shift pedals help minimise the risk of breakage in the event of a fall, while it is also easy to switch between traditional and reverse shifting configurations.

Suspension.

The SP model shares with the Streetfighter V4 S version Öhlins NIX-30 fork, Öhlins TTX36 rear shock absorber and Öhlins steering damper controlled by the second generation Öhlins Smart EC 2.0 system. Unlike the S version, the new machine has the same Panigale V4 springs and hydraulic. The only difference is a fork spring preload reduced from 11mm to 6mm.



ENGINE

The Streetfighter V4 SP engine

Injecting the Streetfighter V4 SP with its soul, sound and speed is the Euro 5 approved 1103cc Desmosedici Stradale engine. With its 90° V4 layout, it boasts MotoGP-derived desmodromic timing.

And if this were not already enough, this engine is the only one of its kind to feature a counter-rotating crankshaft and "Twin Pulse" firing order. It delivers 208 hp at 13,000 rpm and maximum torque of 123 Nm at 9500 rpm.

For ultimate control on track, even during the most aggressive downshifting, the 90° V4 of the

Streetfighter V4 SP harnesses a 9-disc STM EVO-SBK dry clutch (more effective than the wet clutch of the Streetfighter V4 S), produced in billet aluminium.

The new clutch also guarantees greater smoothness during all "off-throttle" phases, as well as the possibility to customise the level of "mechanical" engine brake, by selecting a different secondary spring among those available in the Ducati Performance catalogue. And by mounting the carbon fibre open clutch cover*, included in the standard equipment, the user can enjoy that metallic sound that Ducatisti love so much.

* Open clutch cover is intended for vehicles used only in closed-course circuit. Operation on public roads is prohibited by law.

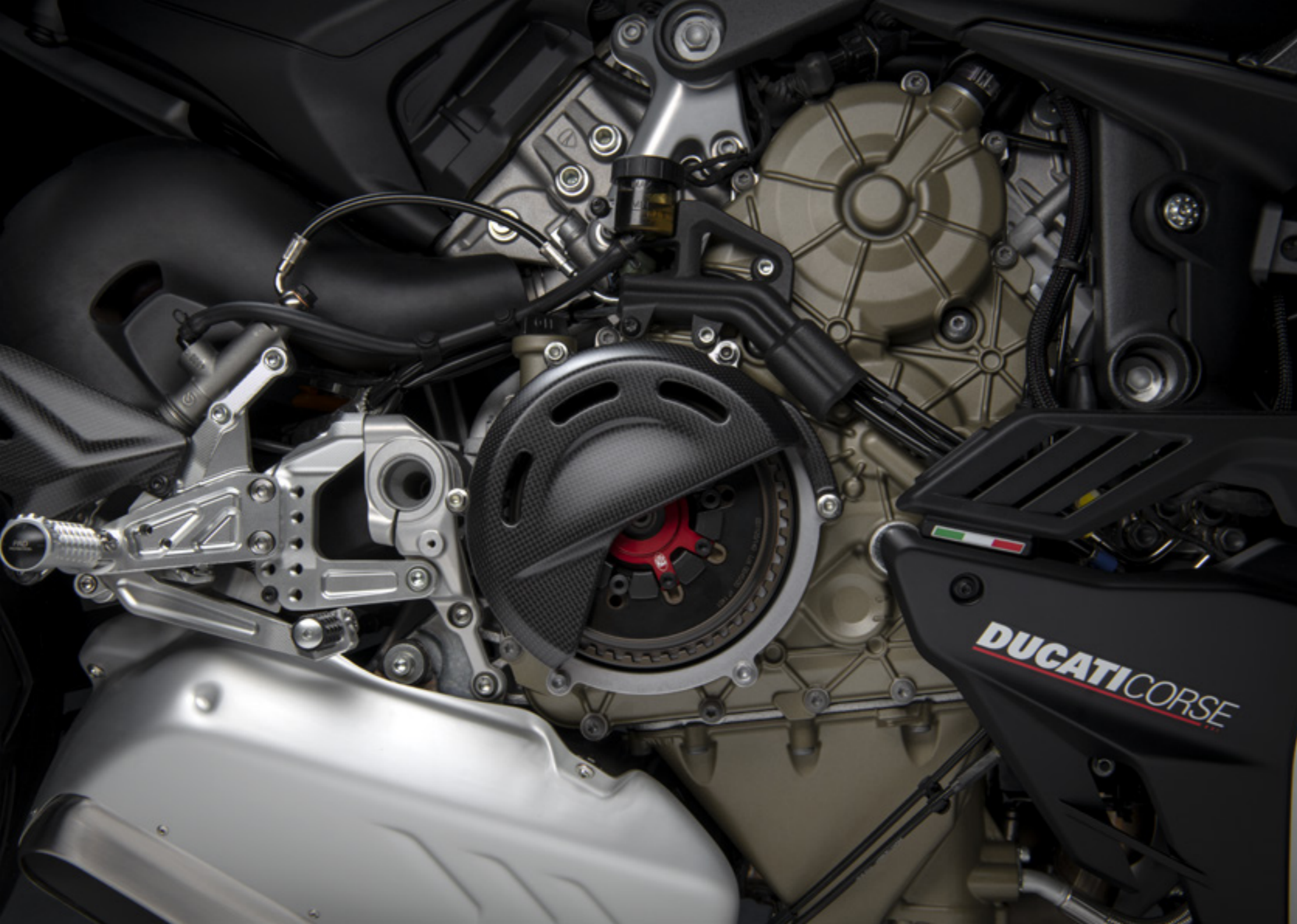

CHASSIS

Chassis for the Streetfighter V4 SP

Carbon wheels* and Brembo Stylema R® front brake callipers are just two of the advantages the Streetfighter V4 SP offers in terms of equipment. Specifically, the split five-spoke rims are created in high-resistance carbon fibre and have aluminium hubs screwed to the composite structure.

The use of these two materials has allowed for a weight saving of 1.4 kg with respect to the forged aluminium wheels of the Streetfighter V4 S, and a 3.4 kg saving with respect to the aluminium wheels of the Streetfighter V4. Dropping wheel weight means reducing the moment of inertia (by 26% at the front and 46% at the rear), for a bike that is considerably more agile and light when changing direction.

The front braking system comprises two 330 mm Brembo discs paired with new Brembo Stylema® R monobloc callipers, with race-derived pistons complete with ventilation holes that improve lever consistency after many laps of the track and reduce residual torque.

* Bike specifications and equipment may vary from market to market. Please refer to your local dealer for further information





Even the design of the footpegs adds to that all-important level of interaction between rider and bike, by allowing for the ideal riding position. Highlighting the attention to detail, the footpegs are produced in high-quality anodised aluminium alloy, which maintains its original appearance over time, and are equipped with carbon fibre heel guards and jointed brake and clutch pedals to minimise the risk of breakage in case of a fall.

Last but not least, the footpegs are designed to be rapidly adjusted from a traditional gear configuration to a reverse shift pattern.

Only the best in terms of suspension, with an Öhlins NIX-30 fork, an Öhlins TTX36 rear shock and an Öhlins steering damper controlled by the second generation Öhlins Smart EC 2.0 system. The Streetfighter V4 SP differs from the S version in terms of its suspension springs and hydraulics, the system identical to that of the Panigale V4 aside from the fact that fork spring pre-load is reduced from 11mm to 6mm.

Servicing and maintenance

Safety as standard

Ducati's continuing commitment to design, research and development has the precise objective of guaranteeing state-of-the-art motorcycles characterised by the highest degree of active safety. It is with racing performance in mind and a view to increasing the level of control during the most difficult riding that we continue to develop systems that are always at the cutting edge.

The Cornering ABS EVO on the Streetfighter V4 controls every moment of braking even when the bike is leaning, which is when the Engine Brake Control EVO system kicks in to fine-tune the braking torque. The acceleration stage is controlled by Ducati Traction Control EVO, Ducati Wheelie Control and Ducati Slide Control. These systems allow the rider to enjoy, in complete safety, the maximum performance of a sport bike belonging to the most powerful series ever built by Ducati.

More value to your passion

With Ever Red, the quality and reliability of the Ducati brand remain your inseparable travelling companions over time. Ever Red is the exclusive Ducati warranty extension programme. With its activation you can continue to feel protected for 12 or 24 months beyond the expiration of the Ducati Warranty (24 months). Ever Red includes roadside assistance for the entire coverage period and no mileage limits. In this way you can ride for all the kilometres you want, even abroad, enjoying your Ducati without any worries.

To find out if the Ever Red extension is available in your country and for further information contact your Ducati dealer or visit ducati.com.

Endless excitement

In designing each bike, Ducati constantly strives to ensure maximum reliability while reducing service costs. A commitment that has seen the intervals for the main Desmo Service, in which valve clearance is checked and adjusted if necessary, extended to 24,000 km (15,000 mi) for the Streetfighter V4. Even the simplest of checks, such as the Oil Service, are extended to 12,000 km (7,500 mi) or 12 months.

A considerable interval for such high-performance engines, which only confirms the high quality standards adopted in terms of material selection and R&D processes. Ducati continuously invests in the technical training of its dealers. The specific skills offered by the official Ducati Service network ensure that all those operations needed to keep every Ducati in perfect condition are thoroughly executed, while advanced equipment such as the Ducati Diagnosis System allows the software on each Ducati to be updated with the latest releases, ensuring that the electronics continue to perform at the maximum level.

Always by your side

One of Ducati's main goals is to offer every Ducatista the chance to enjoy unlimited and safe travel all over the world. To achieve this aim, Ducati offers a "fast delivery" original spares service, with delivery in 24/48 hours across 85% of the areas in which it operates. With a distribution network that covers more than 91 countries, thanks to 738 official Dealers and Service Points*, choosing a Ducati means you can travel worry free and in total freedom, wherever the road may take you, and count on support from our extensive Dealer network that ensures Ducati quality and professionalism is always close at hand.

738 Authorised dealers and service points

91 World countries

*Information updated as of February 2021



Ever Red
Extended Warranty



*Equal to 18,000 miles.



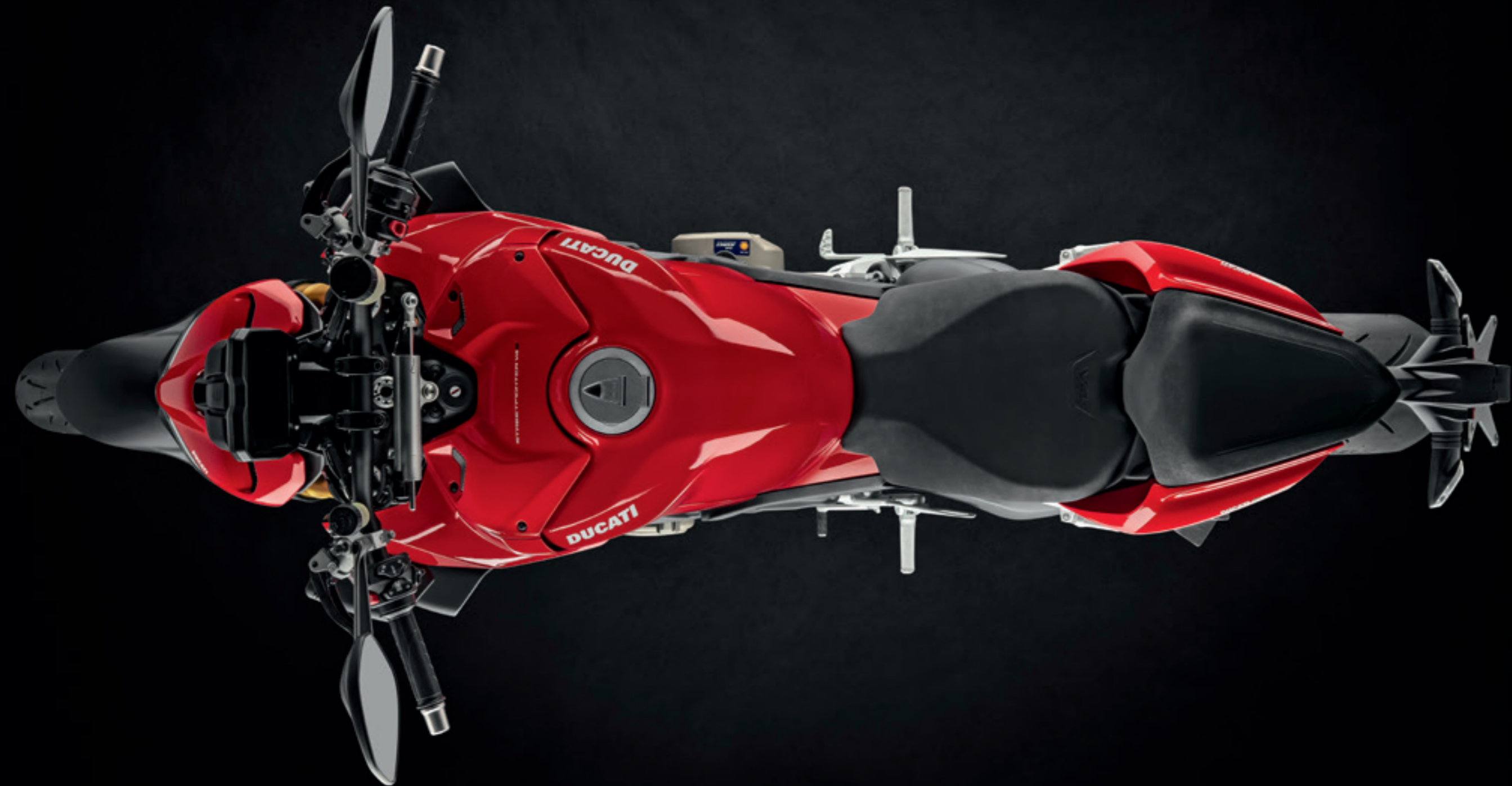

Technical data and equipment

STREETFIGHTER V4

Dimensions

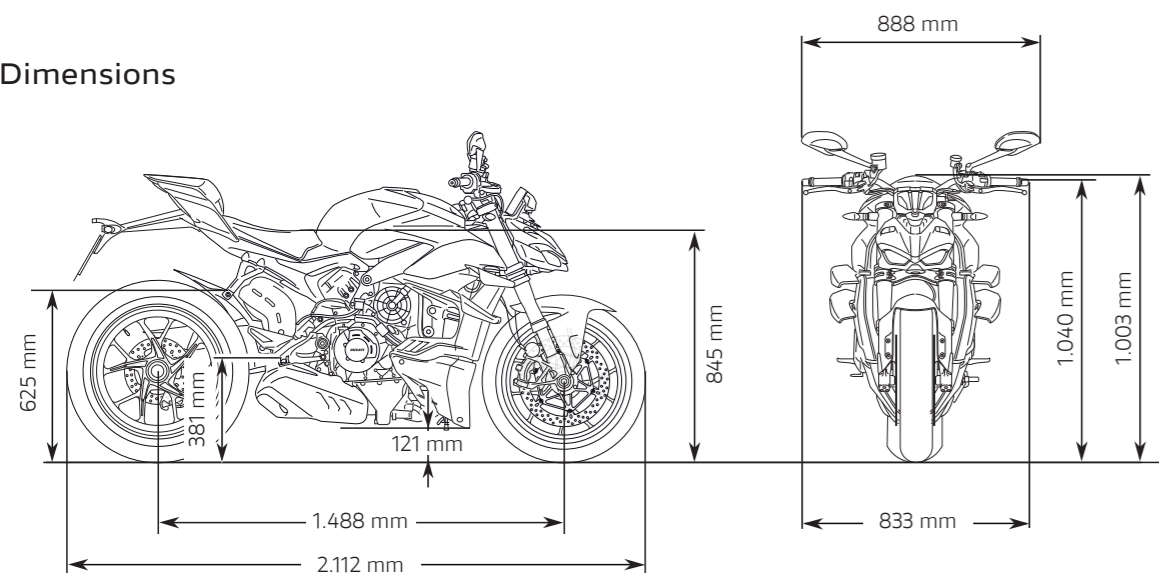

Power and torque

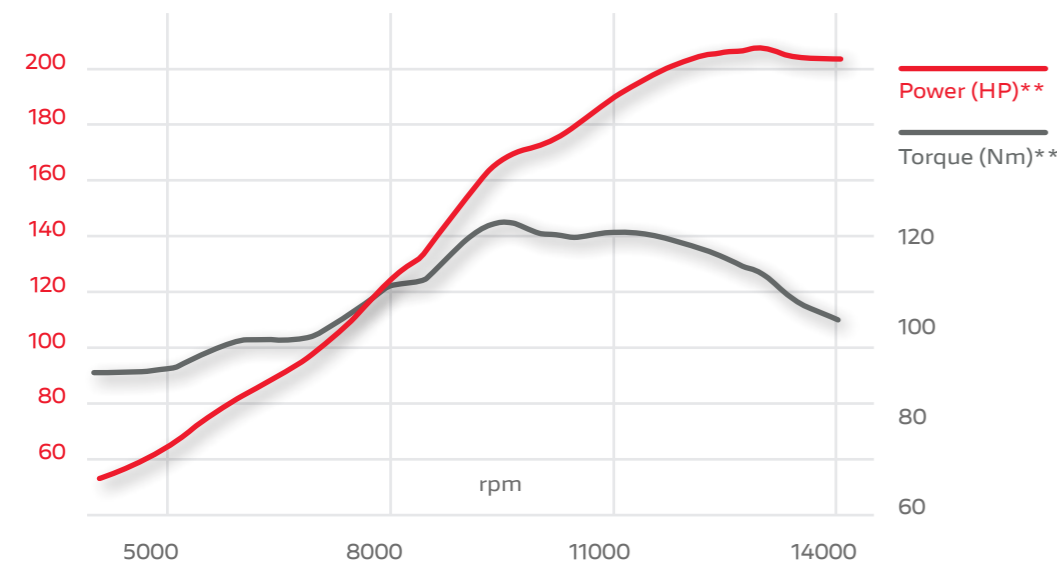

Engine

Engine Desmosedici Stradale 90° V4, counter-rotating crankshaft, 4 Desmodromically actuated valves per cylinder, liquid cooled

Displacement 1,103 cc

Bore X stroke 81 x 53.5 mm

Compression ratio 14.0:1

Power 208 HP (153 kW) @ 13,000 rpm**
208 HP (153 kW) @ 12,750 rpm

Torque 90.4 lb-ft (123 Nm) @ 9,500 rpm**
90.4 lb-ft (123 Nm) @ 11,500 rpm

Fuel injection Electronic fuel injection system. Twin injectors per cylinder. Full ride-by-wire elliptical throttle bodies.

Exhaust 4-2-1-2 layout. Four lambda probes and two catalytic converters**
4-2-1-2 layout. Two lambda probes and two catalytic converters

Transmission

Gearbox 6-speed with Ducati Quick Shift (DQS) up/down EVO 2

Primary drive Straight cut gears; ratio 1.80:1

Ratios 1=38/14 2=36/17 3=33/19 4=32/21
5=30/22 6=30/24

Final drive Chain; Front sprocket 15; Rear sprocket 42

Clutch Hydraulically controlled slipper and self-servo wet multiplate clutch. Self bleeding master cylinder

Chassis

Frame Aluminium alloy "Front Frame"

Front suspension Fully adjustable 43 mm chromed steel upside down (USD) Showa BPF fork

Front wheel 5-spoke light alloy, 3.50" x 17"

Front tyre Pirelli Diablo Rosso Corsa II 120/70 ZR17

Rear suspension Fully adjustable Sachs damper. Single-sided aluminium swingarm

Rear wheel 5-spoke light alloy, 6.00" x 17"

Rear tyre Pirelli Diablo Rosso Corsa II 200/60 ZR17

Wheel travel (front/ rear) 120 mm (4.7 in) - 130 mm (5.1 in)

Front brake 2 x 330 mm semi-floating discs, radially mounted Brembo Monobloc Stylema® (M4.30) 4-piston callipers with Cornering ABS EVO. Self bleeding master cylinder.

Rear brake 245 mm disc, 2-piston calliper with Cornering ABS EVO

Instrumentation Next generation digital dashboard with 5" TFT colour display

Dimensions and weights

Dry weight 180 kg (397 lb)

Weight in running order 201 kg (443 lb)

Seat height 845 mm (33.3 in)

Wheelbase 1.488 mm (58.6 in)

Rake 24.5°

Front wheel trail 100 mm (4 in)

Fuel tank capacity 16 l - 4.23 gallon (US)

Number of seats Two-seater

Safety and technical equipment

Riding Modes, Power Modes, Cornering ABS EVO, Ducati Traction Control (DTC) EVO, Ducati Wheelie Control (DWC) EVO, Ducati Slide Control (DSC), Engine Brake Control (EBC) EVO, Auto tyre calibration

Standard equipment

Ducati Power Launch (DPL), Ducati Quick Shift (DQS) up/down EVO 2, Full LED lighting with Daytime Running Light (DRL*), Sachs steering damper, Quick adjustment buttons, Auto-off indicators, Passenger seat and footpegs.

Ready for

Ducati Data Analyser+ (DDA+) with GPS module, Ducati Lap Timer GPS (DLT GPS), Ducati Multimedia System (DMS), Anti-theft system, Heated hand grips

Warranty

Warranty (months) 24 months unlimited mileage

Maintenance (km/months) 12,000 km (7,500 mi)/12 months

Valve clearance adjustment (km) 24,000 km (15,000 mi)

Consumption and Emissions **

Standard Euro 5

Consumption and Emissions 7,6 l/100km - CO2 178 g/km



* equal to 18,000 miles.

Kilometres refer to the first Desmo Service, i.e. when the valve clearance is checked and adjusted if necessary.

*Bike specifications and equipment may vary from market to market. Please refer to your local dealer for further information.

** Only for countries where Euro 5 standard applies.

STREETFIGHTER V4



	Streetfighter V4	Streetfighter V4 S	Streetfighter V4 SP*
Front suspension	Fully adjustable Showa BPF fork. 43 mm chromed inner tubes	Öhlins NIX30 43 mm fully adjustable fork with TiN treatment. Electronic compression and rebound damping adjustment with Öhlins Smart EC 2.0 event-based mode	Öhlins NIX30 43 mm fully adjustable fork with TiN treatment. Electronic compression and rebound damping adjustment with Öhlins Smart EC 2.0 event-based mode
Rear suspension	Fully adjustable Sachs unit.	Fully adjustable Ohlins TTX36 unit. Electronic compression and rebound damping adjustment with Öhlins Smart EC 2.0 event-based mode.	Fully adjustable Ohlins TTX36 unit. Electronic compression and rebound damping adjustment with Öhlins Smart EC 2.0 event-based mode.
Steering damper	Sachs	Öhlins Smart EC 2.0	Öhlins Smart EC 2.0
Front wheel	5-spokes light alloy	3-spokes forged aluminum Marchesini	5-split spokes carbon fiber
Rear wheel	5-spokes light alloy	3-spokes forged aluminum Marchesini	5-split spokes carbon fiber
Dry weight	180 kg (397 lb)	178 kg (392 lb)	177 kg (390 lb)**
Weight in running order	201 kg (443 lb)	199 kg (439 lb)	196 kg (432 lb)**



1 NIX30 Öhlins fork with event-based mode controlled by Öhlins Smart EC 2.0

2 Marchesini aluminium forged wheels

3 Öhlins Smart EC TTX36 damper

* The image shows the Streetfighter V4 SP equipped with an open clutch cover, license plate holder removal kit, rear-view mirror hole covers prohibited for use on public roads.

** Bike specifications and equipment may vary from market to market. Please refer to your local dealer for further information

STREETFIGHTER V4 SP

Equipment Streetfighter V4 SP

Handlebar engraved with progressive bike number

Visible brushed aluminium tank

Dedicated seat with "V4 SP" logo

Carbon fibre wings

Carbon fibre front mudguard

STM-EVO SBK dry clutch

Split five-spoke wheels in carbon fibre*

Brembo Stylema R front brake callipers*

Adjustable rider footpegs in billet aluminium with carbon heel guards

Single seat configuration

Lithium ion battery

Open clutch cover in carbon** (supplied)

Licence plate holder removal cover** (supplied)



* Bike specifications and equipment may vary from market to market. Please refer to your local dealer for further informatio

** Open clutch cover and removing license plate holder kit are intended for vehicles used only in closed-course circuit. Operation on public roads is prohibited by law.

The image shows the Streetfighter V4 SP equipped with an open clutch cover, license plate holder removal kit, rear-view mirror hole covers prohibited for use on public roads.

STREETFIGHTER V4

Ducati Red



STREETFIGHTER V4 S

Ducati Red



STREETFIGHTER V4 S

Dark Stealth



STREETFIGHTER V4 SP

Winter Livery



The image shows the Streetfighter V4 SP equipped with an open clutch cover, license plate holder removal kit, rear-view mirror hole covers prohibited for use on public roads.

ACCESSORIES

Configure the Ducati of your dreams.

Streetfighter V4 SP means optimum Ducati technology, performance, and comfort. The modern and technological Ducati naked bike has immediately enjoyed great success among motorcyclists all over the world, also confirmed by the positive feedback from the international media.

Configure

Choose the ideal Multistrada V2 for you and have fun configuring it to suit your riding style! Share your Multistrada V2 with friends and send it to your Ducati dealer who will contact you for an online consultation to discuss the current offers that best suit your needs.

Save your configuration to return to it at any time.

Calculate your payment

Ducati Financial Services offers favourable solutions for the financing of every model in the Ducati range. Personalise your financing and calculate the monthly instalments. You can then contact your dealer and discuss the best way to see your dream come true!



Go to configurator

For more information about the Ducati Performance range, tech specs and instructions, refer to a Ducati dealer or visit the Accessories section of ducati.com

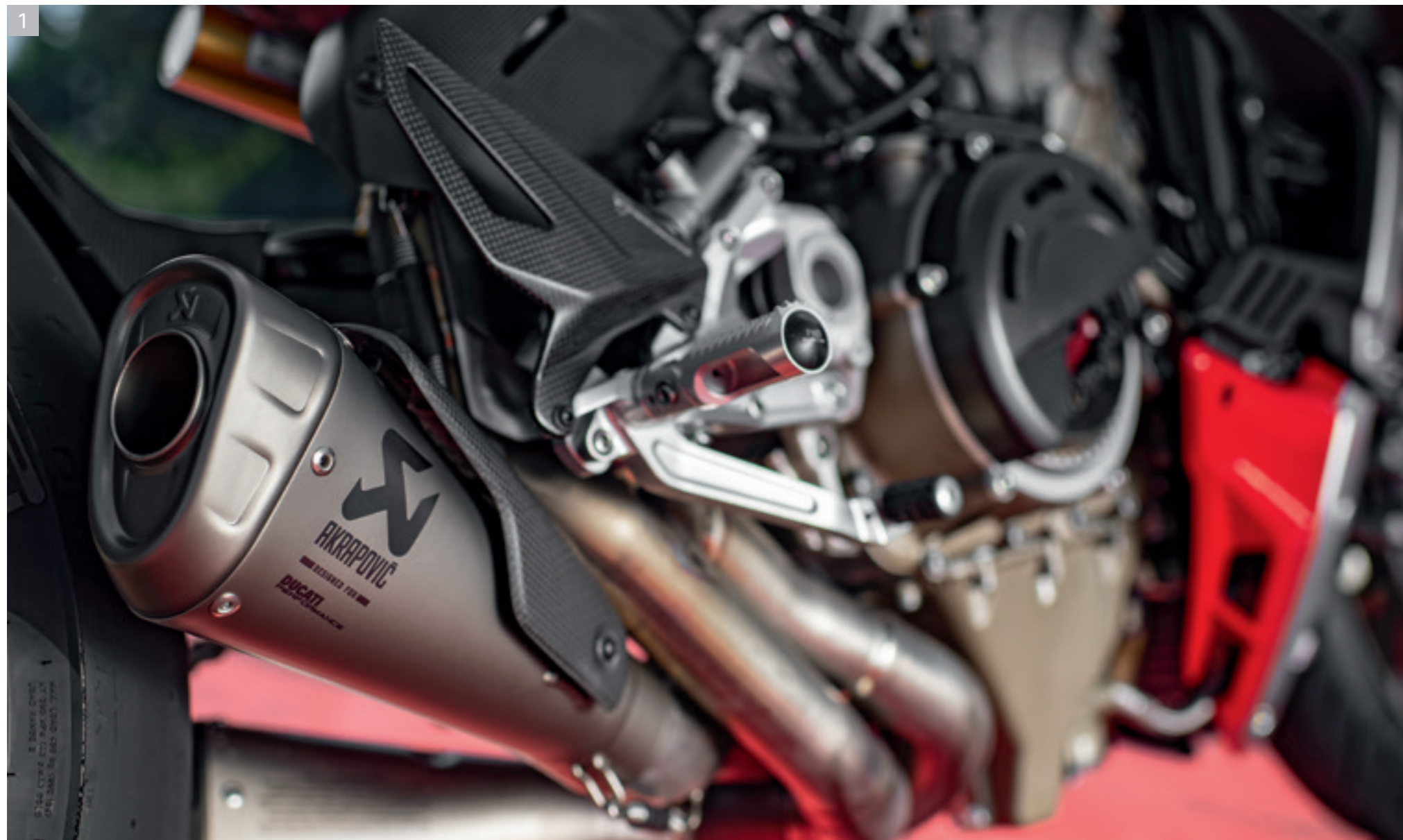

1 Complete titanium exhaust assembly

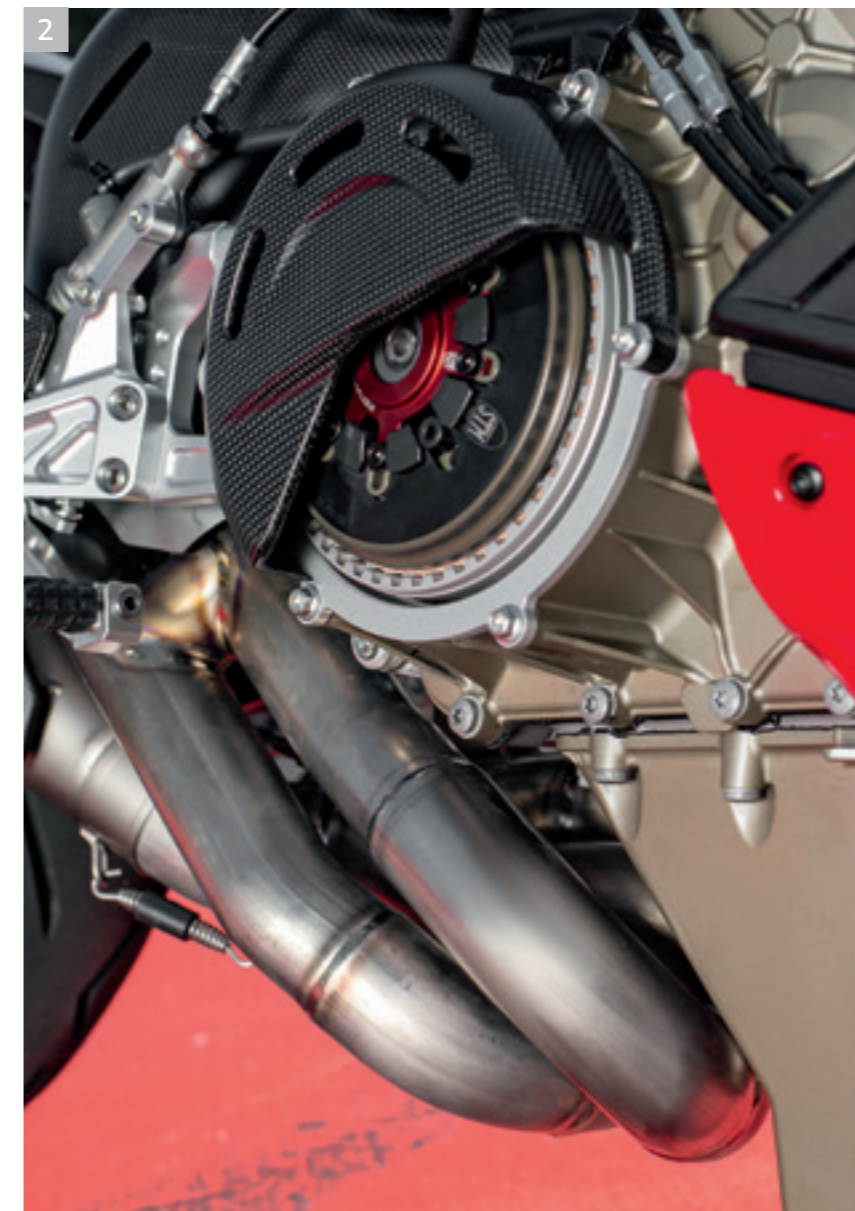

2 Dry clutch kit



3 Carbon dry clutch cover



2 Carbon heel guard
Adjustable rider footpegs in aluminium



2 Clutch and brake fluid reservoir
3 Carbon protection for generator cover



4 Magnesium rims



1 Carbon tank cover
Billet aluminium tank cap



2 Clutch lever
Handgrips Pro grip
Billet aluminium handlebar balancing weights



3 Carbon rear mudguard
4 Carbon front mudguard



Apparel

Ducati Corse C5
Racing suit

Ducati Corse K1
Racing suit

Ducati Corse C5
Racing suit

Ducati Corse |D |air® C2
Racing suit with airbag system

Speed Evo
Full-face helmet

Ducati Corse V5
Full-face helmet

Ducati Corse Speed 2
Full-face helmet

Ducati Corse V5 Air
Racing boots

The configurator that allows you to create a layout for your SuMisura suit is available on the site www.ducatisumisura.com.





Fighter C1
Leather-fabric jacket

Speed Evo
Full-face helmet





Speed Air C1
Leather gloves





Ducati Digital Experience

A mission for every channel. Continuous updating on the innovation and passion for which our work stands out. We transform emotions into exclusive content. Just a click away.

Follow us on:

-  www.ducati.com
-  [@ducati](#)
-  [@DucatiMotor](#)
-  [Ducati Motor Holding](#)

-  [@ducati](#)
-  [Ducati Motor Holding](#)
-  [@ducati_official](#)

MyDucati App

MyDucati is the personal area for every Ducatista, offering a wide range of services accessible with a single login from both the web and the app. Explore all the features of the MyDucati world and enjoy a multi-channel, customised experience wherever you are.

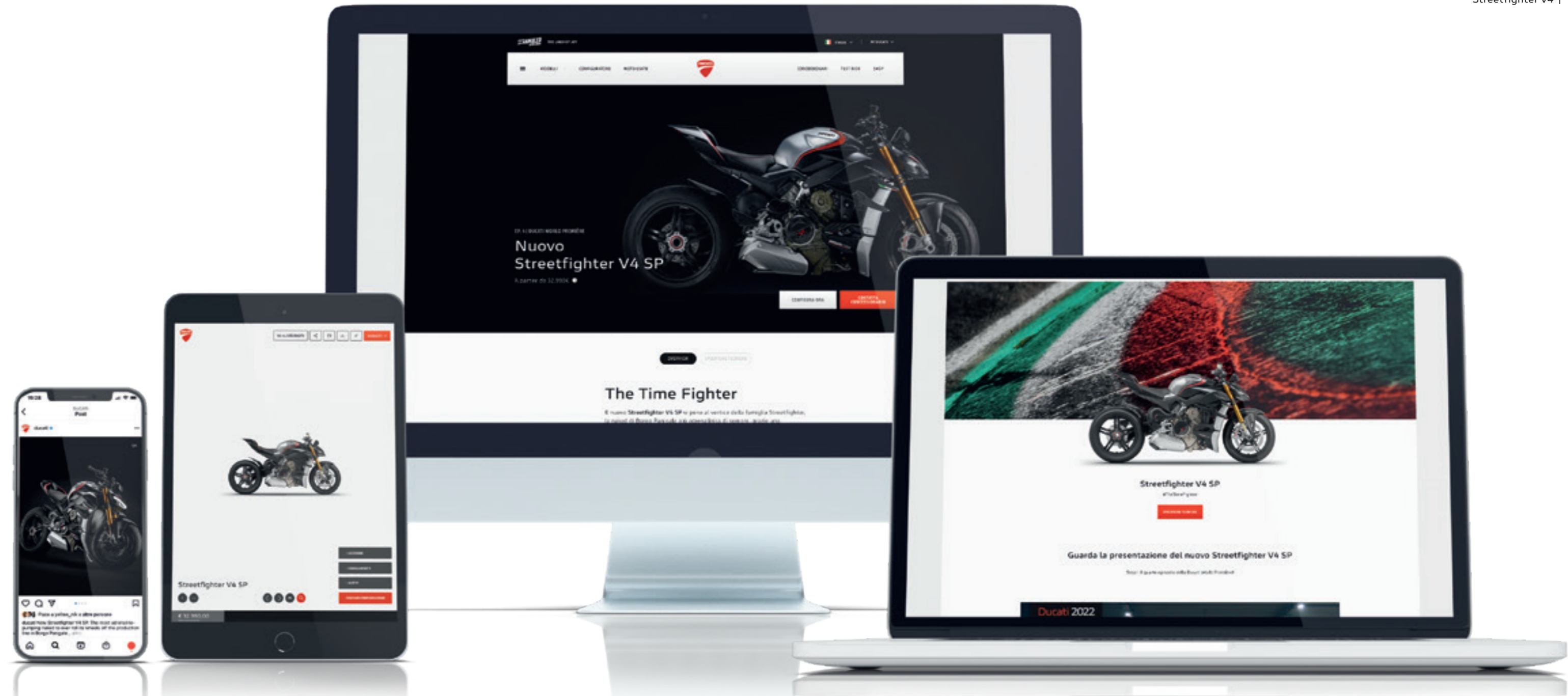

Riding a motorcycle is the most exciting way to enjoy the road, and offering the utmost safety to the motorcyclist is Ducati's commitment. Ducati bikes are increasingly easy to handle, reliable and better equipped to guarantee maximum safety and enhance riding pleasure. Technical clothing is made with more and more advanced materials for adequate protection and increased visibility. The safety of motorcyclists is Ducati's commitment. For more information visit the safety section of the Ducati site (www.ducati.com).

Warning: The photos and technical information in this catalogue may refer to prototypes subject to modifications during production and are purely for illustration and reference purposes, and are therefore not binding on Ducati Motor Holding S.p.A. Sole Shareholder Company - Company subject to the direction and coordination of AUDI AG ("Ducati"). Ducati cannot be held responsible for any print and/or translation errors. This catalogue is transnational and therefore some products may not be available and/or their features may vary in accordance with local laws. Not all colours and versions are available in each country. Ducati reserves the right to make changes and improvements to any product without obligation of prior notice or to make such changes to products already sold. Further characteristics of the products are contained in the pertinent owner's manuals. The products represented are not definitive versions and are therefore subject to significant changes at Ducati's discretion without prior notice. The photographs published in this catalogue show

only professional riders under controlled street conditions. Do not attempt to imitate such riding behaviour as it could be dangerous for you or other people on the road. This catalogue, including but not limited to the trademarks, logos, texts, images, graphics and table of contents herein, constitute Ducati intellectual property, or in any event Ducati has the right to reproduce it; any reproduction, modification or other whole or partial use of the catalogue or its contents, including publication on the Internet without the prior written consent of Ducati, is prohibited.

Actual fuel consumption may vary based on many factors, including but not limited to riding style, maintenance performed, weather conditions, surface characteristics, tyre pressure, load, weight of the rider and the passenger, accessories.

Ducati indicates the dry weight of the motorcycle excluding battery, lubricants and coolants for liquid-cooled models. The weights in running order are considered with all operating fluids and the fuel tank filled to 100% of its useful capacity (Regulation (EU) no. 168/2013). For more information visit www.ducati.com.

December 2021.



WDW2022
WORLD DUCATI WEEK
22 - 24 Luglio / Misano, Italia
wdw.ducati.com