

MONSTER





Index

Just Fun!	5
A concentration of style, sport and fun	7
Monster at first sight	8
Never again without it	11
The new Monster design	13
Simplicity and fun. In one word: Monster.	19
Dream. Feel. Thrill	20
Rookie Academy: Level Up your Ride	23
Easy, intuitive, manageable	26
All you need to have fun	31
Cutting-edge technology	32
Servicing and maintenance	38
Technical data and gear	41
More unique than ever	48
Monster, as you like it	52
Monster, as you wear it	58



Just Fun!

Climb aboard. Turn on the engine. Open the throttle and forget everything else. Become what you've always wanted to be. Experience something you previously only imagined. No frills, no formality. Just sheer fun. This is a bike that gets straight to the point. This is the naked you've been waiting for, because it fits like a second skin. New Monster. Just fun!

The photographs published in this catalogue portray professional riders in controlled road riding conditions. Do not imitate such riding behaviour, which may pose a danger to yourself or other road users.

The photos in this brochure are representative of the European version of the bike, which may differ in different countries depending on local regulations.





A concentration of style, sport and fun

The new Monster will have you wanting to do away with the superfluous and focus only on what counts, sheer riding pleasure. You can be sure to improve as a rider, experience intense emotions and enjoy yourself every time you climb on board.

Monster at first sight

Lightweight and compact. Agile and sleek. The design of the new Monster is exactly what you might expect from the sport naked par excellence, but in an even more cutting-edge and modern guise. Slinky yet aggressive curves. Classic details with a modern twist. A design that aims to offer pure Monster-style emotion.





Never again without it

Precise through the turns. Stable along the straight. Completely at ease whether in city traffic or on track. The new Monster will trace your every movement, thanks to an advanced yet intuitive chassis that ensures a fun and fulfilling ride.

Created for your enjoyment

Experience the pleasure of a controlled ride. Unleash the power and fluidity of the 937 cc Testastretta 11° engine. Thanks to a sophisticated chassis and electronic equipment at the service of the rider, putting yourself to the test has never been such fun.



DESIGN

The new Monster design

The iconic, timeless style of the Monster enters a new era with a contemporary, cutting-edge design. All the distinctive elements are there, such as the engine, the undisputed scene-stealer, topped with the classic "bison-back" tank, the circular headlamp built into the 'shoulders', and the clean, streamlined tail section. But all with a more modern, sporty, and technological twist, designed to enhance the bike's personality and maximise rider enjoyment.





The tank is the visual centre of attention. The muscular Monster bison-back, complete with its deep sculpted hollows for the knees, boasts bulkier 'shoulders' that now extend towards the front wheel and loom over the dynamic turn signals, integrated into the two lateral wings*. Its proportions are also revised, now more compact to support ergonomics that prioritise comfort and efficiency.

*Please check with your dealer feature availability.





The short tail, sleek yet sinuous and sculpted, comprises a visible rear subframe in glass fibre reinforced polymer, which serves both a structural and an aesthetic function, and two polished side panels.

The full LED headlamp retains the iconic spherical shape of the Monster but is modernised with the bright signature of the DRL daytime running lamp*. The structure of the headlamp is also updated with a transparent dome that fully integrates both the optic and electronic elements. Technical elements such as the fully visible central module and heat sink blend the modern and the technological.

*Please check with your dealer feature availability.





Simplicity and fun. In one word: **Monster.**

Easy, intuitive, sporty and fully customisable. The new Monster is ready to offer maximum enjoyment to anyone who rides it.

Lightweight and compact, it knows exactly how to accommodate any rider, even during low-speed manoeuvres.

The riding position, not overly loaded at the front, inspires confidence and safety, offers maximum comfort and zero stress, and is fun and efficient even during sports use.

The seat position is comfortable and secure, thanks to a saddle height of 820 mm (32.3 in), which can be reduced to 800 mm (31.5 in) with a dedicated low saddle available as an accessory, or even 775 mm (30.5 in) with the lowered suspension kit.

The brake and clutch levers are adjustable to allow every rider to alter lever position to suit their hand.

The hydraulic slipper clutch operates in an oil bath and is incredibly soft and easy to activate, particularly in the city, thanks to its unique assist system.

The Quick Shift up & down ensures smooth shifting and easy, precise gear insertion, doing away with the need for the clutch. The result? More enjoyable sports riding and less effort in an urban setting.

With the new Sport, Touring and Urban Power Modes, riders can modify bike behaviour depending on the road conditions and their riding preferences, even while on the move. The Smart functionality means dedicated torque curves in the lowest gears limit traction control intervention for an even more intuitive riding experience.

The reduced steering diameter that results from the boosted steering angle (36°) allows the new Monster to turn even in a restricted space, simplifying life in the city and in any situation where there is little space to manoeuvre.

Dream. Feel. Thrill

The new Ducati Monster is sheer riding pleasure and absolute control. It is the sports naked for everyone, from the inexperienced rider starting out on their two-wheel journey, to the expert who wants to have fun with a quick and agile bike, on and off the track.

The new Monster grows in terms of its engine size, power and torque but loses weight to ensure agility, performance, and riding ease in every situation. **The new Monster has a dry weight of just 166 kg** and mounts an engine that boasts maximum power of 111 HP (82 kW) and maximum torque of 9.5 kgm (93 Nm, 69 lb ft).

All the fun, performance and technology of the new Monster is also **available as a 35kW restricted-power version for those with an A2 licence**. Contact your dealer to check availability.





DRE ROOKIE

Rookie Academy: Level Up your Ride

DRE Rookie is the DRE Academy course dedicated to young riders, from 18 to 24 years of age, who possess an A2 licence and ride restricted bikes. The professional team of instructors will teach participants all the tricks they need to acquire and develop the right techniques and improve their riding, safely and enjoyably.

DRE Rookie stems from a Ducati project dedicated to riding safety and highlights the company's commitment to promoting the concept of safe and responsible riding.

Your development starts here: climb aboard, boost your riding ability, and unleash your potential as a rider!



CHASSIS

Sheer riding pleasure

A dry weight of 166 kg (366 lb), or rather 18 kg (40 lb) less than the Monster 821. An extraordinary saving made possible thanks to meticulous work to drop weight across every single component for an agile and manageable bike.

But as well as being incredibly light, the new Monster is also extremely compact, with a wheelbase that is reduced to 1,474 mm (58.0 in).

1- Front Frame

The engine is load-bearing, connected to a Front Frame that is similar in concept to that of the Panigale V4. Created in aluminium, it is 4.5 kg (10 lb) lighter than the trellis frame of the Monster 821, for a 60% reduction in weight that contributes to the bike's overall lightness.

2- Sub-frame

The rear sub-frame – created in GFRP (Glass Fibre Reinforced Polymer) – is 1.9 kg (4 lb) lighter and adds to the clean, sports design of the new Monster.

The chassis of the new Monster is extremely functional and efficient. With solutions designed to offer easy, intuitive riding, the new Monster inspires confidence in all conditions and is always able to elevate your abilities as a rider, whatever your level.



3- Seat height

The seat is positioned 820 mm (32.3 in) from the ground. This, combined with the bike's narrow sides, a result of the Front Frame, ensure that the rider can easily touch the ground with their feet. A lower 800 mm (31.5 in) saddle that still incorporates comfortable padding is available as an accessory. And for those who want it, a simple suspension kit that lowers the vehicle is also available, allowing the rider to further reduce the seat height to 775 mm (30.5 in).

4- Hydraulic clutch

The slipper clutch that equips the Monster works in an oil bath and is extremely soft to use thanks to a specific assist system. With a new hydraulic control, it is extremely 'light' to activate (20% less effort on the lever with respect to the Monster 821) to satisfy riders of all experience levels. The gearbox has been redesigned to improve shifting precision. Mounted as standard, the Quick Shifter is the perfect companion during sports riding thanks to the support it provides when up- and down-shifting, but it is also a cure-all when riding city streets, as the rider need only use the clutch when making a standing start.

The conical aluminium handlebar and radial brake and clutch pumps are quality components that round out the high-level equipment on the new Monster. And for more intense sports feeling, riders can make use of the Ducati Performance exhaust kit by Termignoni, available with a homologated slip-on silencer or as a full racing version.

1- Braking system

In developing the new Monster braking system together with Brembo, the goal was to offer the best possible braking performance, while retaining excellent modulation and light, accurate activation. A system in which M4-32 monobloc radial callipers act on a pair of 320 mm front discs.



2- Tyres and wheels

Even the wheels, 1.7 kg (4 lb) lighter, contribute to the overall weight saving of the new Monster. Created in lightweight alloy, they measure 3.5" x 17" and 5.5" x 17" and mount Pirelli Diablo Rosso III tyres in size 120/70 at the front and 180/55 at the rear. Perfectly suited to the sports nature of the Monster in both wet and dry conditions, the tyres offer maximum grip when leaning over.

3- Steering angle

The new frame, as well as the careful positioning of elements like the radiator, has allowed for one big improvement with respect to the previous generation of Monster. Specifically, the steering angle is now raised to 36°, a good 7° increase. The Monster has never been so agile in traffic or through the bends, and is also easy and intuitive when changing direction.

4- Engine

The Monster mounts the 937 cc Testastretta 11° L twin engine complete with Desmodromic timing and Euro 5 homologation*. It weighs 2.6 kg (6 lb) less than the 821 cc engine despite its increased size, thanks to its many redesigned components.

* Only for countries where Euro 5 standard applies.

ENGINE

All you need to have fun

Cutting-edge performance and unrivalled riding pleasure. The latest evolution of Testastretta 11° twin makes the new Monster your ideal partner.

With many of its components redesigned to reduce weight while maintaining performance and reliability, the 937 cc Testastretta 11° is smooth and controlled at low rpm, for a prompt response in city traffic, but also dynamic at medium-high rpm for electrifying performance at all times.

It is equipped with the Quickshifter Up/Down to ensure fast and precise shifting, both up and down the gears, without the use of the clutch. The advanced engine guarantees disarmingly simple excitement and fun.

With 937 cc, maximum power of 111 HP (82 kW) at 9250 rpm and maximum torque of 9.5 kgm (93 Nm, 69 lb ft) at 6500 rpm, the Testastretta 11° combines ultimate power and sportiness with an extremely precise and very manageable ride. The engine is Euro 5* compliant while respecting the family feeling. The L-shaped layout, liquid cooling, Desmodromic valve actuation system and characteristic sound quality are all unmistakable traits of a Ducati engine, also available in a 35kW restricted version.

* Only for countries where Euro 5 standard applies.



ELECTRONICS

Cutting-edge technology

Power Modes on the new Monster are equipped with Smart functionality. In the lowest gears, dedicated torque curves that differ for each Power Mode reduce the level and frequency of control system intervention, for more manageable and intuitive bike usage.

There are three Smart Power Modes: High Power Mode (associated with Sport Riding Mode): a dedicated torque curve in 1st gear and a full torque curve in the remaining gears.

Medium Power Mode (Touring): dedicated torque curves in 1st and 2nd gears and a full torque curve in the remaining gears.

Low Power Mode (Urban): dedicated torque curves in 1st and 2nd gears and a limited torque curve (max. power 75 HP) in the remaining gears.

You can select the strategy you want based on the road conditions and personal preference at any time, even on the move, thanks to controls on the handlebar and indications on the dash. You can also customise each Riding Mode, modifying the default traction control, wheelie control and Cornering ABS intervention values, to create your very own Monster, tailor made to suit your riding style.



Every moment aboard the new Monster will see the rider express their full potential, thanks also to the complete electronics package that fully supports the rider, combining sports performance with a high level of active safety.

Cornering ABS, adjustable according to three levels, comes as standard and ensures responsive braking in maximum safety, even when the bike is at an angle. More expert riders can make use of the ABS front-only mode, which deactivates ABS at the rear wheel for sports riding.

Even the acceleration phase is worry-free thanks to Ducati Traction Control (DTC) and Ducati Wheelie Control (DWC) – both in a Cornering version - which intervene electronically to limit rear wheel slide and front wheel lift.

With Ducati Power Launch, present for the first time on the Monster, you can be sure to make a spectacular getaway. Offering three levels, the system regulates torque delivery so that all you need do is release the clutch.



The new full LED headlamp, with its modern lines and technological look, is equipped with the daytime running light system* that guarantees excellent visibility, near and far.

The new LED turn signals ensure a rider remains visible and heighten safety with their auto-off function, which prevents them blinking for too long if left on. The rear light is also LED, so that the rider is always easily identifiable, even at a distance and in full daylight.



*Please check with your dealer feature availability.



Whatever your path or reason for riding, you will always have everything under control thanks to the new 4.3" high-res TFT display. Equipped with an extremely intuitive, complete, and easy to use HMI (Human Machine Interface), it adopts graphics inspired by those of the Panigale V4, sporty and easy on the eye.

And to expand your connectivity experience, the dash is set up for the Ducati Multimedia System, which allows a smartphone to be connected to the bike with a Bluetooth module, available as an accessory, so as to be able to manage functions such as music and calls via the handlebar controls.

Servicing and maintenance

Safety as standard

The constant work that Ducati carries out in terms of design, research and development has the precise aim of ensuring increasing cutting-edge bikes that are characterised by maximum levels of active safety. A commitment that involves the definition of increasingly advanced systems to increase the rider's level of control, such as Cornering ABS, traction control and wheelie control. Equipment that optimises bike behaviour in both braking and acceleration and that offers numerous possibilities for adjustment with different intervention levels for the ABS, traction control and wheelie control, which the rider can select.

More value to your passion

With Ever Red, the quality and reliability of the Ducati brand will be your enduring travel companions. Ever Red is the exclusive Ducati warranty extension programme. In activating it, you will continue to be fully protected for 12 or 24 months beyond the standard Ducati Warranty period (24 months). Ever Red includes roadside assistance for the entire period of coverage and does away with mileage limits. This means you can travel as far as you wish, even overseas, enjoying your Ducati with complete peace of mind.

To find out whether the Ever Red extension is available in your country and for further details, refer to your Ducati dealer or visit ducati.com.

Endless excitement

In designing each bike, Ducati constantly strives to ensure maximum reliability while reducing service costs. A commitment that has seen the intervals for the main Desmo Service, in which valve clearance is checked and adjusted if necessary, to be extended to 30,000 km (18,000 mi) for the Monster.

Even the simplest of checks, such as the Oil Service, are extended to 15,000 km (9,000 mi) or 12 months. A considerable interval for such high-performance engines, which only confirms the significant quality standards applied to material selection and R&D processes.

Ducati continuously invests in the technical training of its dealers. The specific skills offered by the official Ducati Service network ensure that all those operations needed to keep every Ducati in perfect condition are meticulously executed, while advanced equipment such as the Ducati Diagnosis System allows the software on each Ducati to be updated with the latest releases, ensuring that the electronics continue to perform at the maximum level.

Always by your side

One of Ducati's main goals is to offer every Ducatista the chance to enjoy unlimited and safe travel all over the world. To achieve this aim, Ducati offers a "fast delivery" original spares service, with delivery in 24/48 hours across 85% of the areas in which it operates. With a distribution network that covers more than 91 countries, thanks to 738 official Dealers and Service Points*, choosing a Ducati means you can travel worry free and in total freedom, wherever the road may take you, and count on support from our extensive Dealer network that ensures Ducati quality and professionalism is always close at hand.

738 Authorised dealers and service points

91 World countries

*information - last update 31 December 2020.



Ever Red

Estensione di Garanzia



*Equal to 18,000 miles.





Technical data and gear

MONSTER

Dimensions

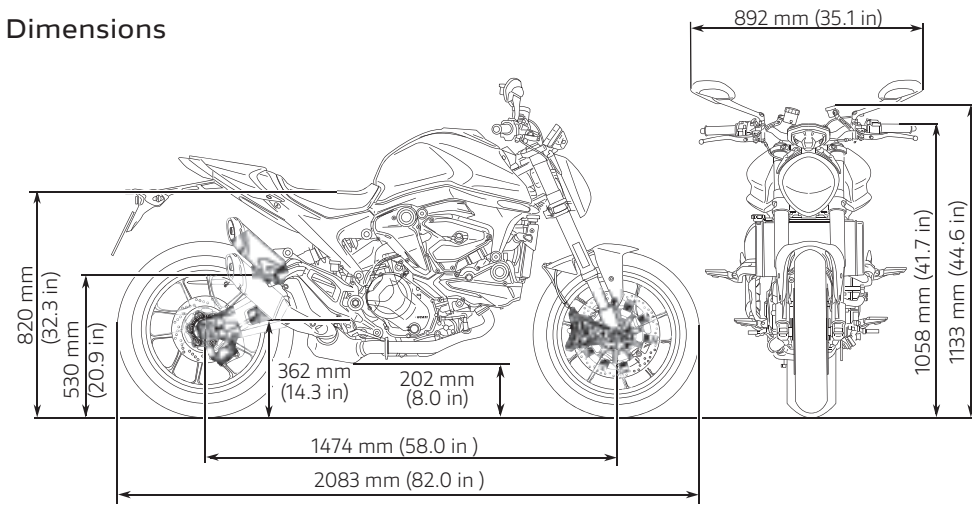

Power and torque

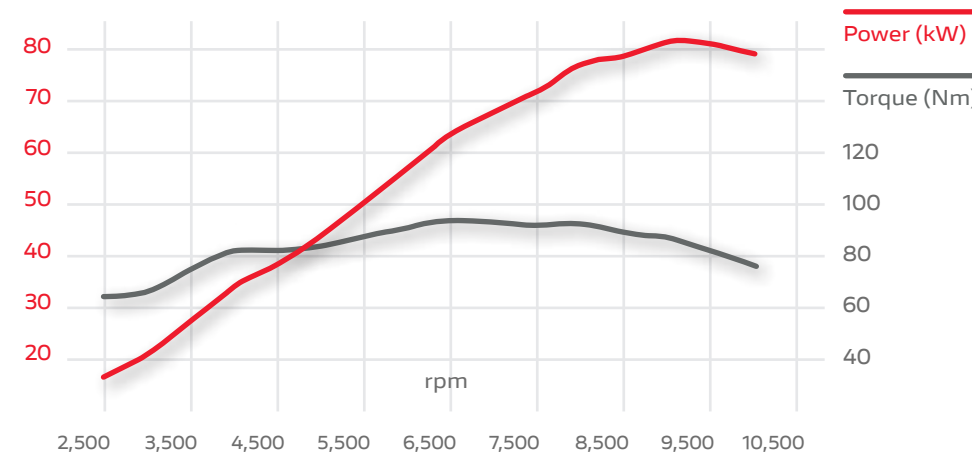

Engine	
Engine	Testatretta 11°, V2 - 90°, 4 valves per cylinder, desmodromic valvetrain, liquid cooled
Displacement	937 cc (57 cu in)
Bore X stroke	94 mm x 67.5 mm
Compression ratio	13.3:1
Power	111 hp (82 kW) @ 9,250 rpm
Torque	9.5 kgm (93 Nm, 69 lb ft) @ 6,500 rpm
Fuel injection	Electronic fuel injection system, Ø 53 mm throttle bodies with Ride-by-Wire system
Exhaust	Pre-muffler and twin muffler, catalytic converter and 2 lambda probes
Transmission	
Gearbox	6 speed
Primary drive	Straight cut gears, ratio 1.85:1
Ratio	1=37/15, 2=30/17, 3=28/20, 4=26/22, 5=24/23, 6=23/24
Final drive	Chain, front sprocket z15, rear sprocket z43
Clutch	Slipper and self-servo multiplate wet clutch with hydraulic control

Chassis	
Frame	Aluminum alloy Front Frame
Front suspension	Ø 43 mm usd fork
Front wheel	Light alloy cast, 3.5" x 17"
Front tyre	Pirelli Diablo Rosso III 120/70 ZR17
Rear Suspension	Progressive linkage, preload adjustable monoshock, aluminium double-sided swingarm
Rear Wheel	Light alloy cast, 5.5" x 17"
Rear tyre	Pirelli Diablo Rosso III 180/55 ZR17
Wheel travel (front/rear)	130 mm / 140 mm (5.1 in / 5.5 in)
Front brake	2 x Ø 320 mm semi-floating discs, radially mounted Brembo M4.32 monobloc 4-piston callipers, radial master cylinder, Cornering ABS
Rear brake	Ø 245 mm disc, Brembo 2-piston floating calliper, Cornering ABS
Instrumentation	4.3" TFT colour display
Dimensions and weights	
Dry weight	166 kg (366 lb)

Kerb weight	188 kg (414 lb)
Seat height	820 mm (32.3 in) 800 mm (31.5 in) (accessory low seat) 775 mm (30.5 in) (accessory low seat + low suspension kit)
Wheelbase	1,474 mm (58.0 in)
Rake	24°
Front wheel trail	93 mm (3.7 in)
Fuel tank capacity	14 l (3.7 US gal)
Number of seats	2
Safety equipment	
Riding Modes, Power Modes, Cornering ABS, Ducati Traction Control, Ducati Wheelie Control, Daytime Running Light**	
Standard equipment	
Ducati Quick Shift, Ducati Power Launch, 4.3" TFT colour display, Full LED headlight and lighting system, Dynamic turn indicators**, USB power socket, Flyscreen (Plus version), Passenger seat cover (Plus version)	
Ready for	
Ducati Multimedia System, Heated grips	

Warranty	
Warranty	24 months, unlimited mileage
Maintenance	
Oil change	15,000 km (9,000 miles) / 12 months
Valve clearance check	30,000 km (18,000 miles)
Emission & Consumptions (only for countries where Euro 5 standard applies)	
Standard	Euro 5
Emission CO ₂	120 g/km
Consumptions	5.2 l/100 km



*Equal to 18,000 miles

Indication of mileage at the first Desmo Service, or rather the first service during which valve clearance is checked and adjusted if necessary.

The Monster is also available for holders of limited driving license in a version with reduced power to 35 kW. Contact your dealer to check availability.

** Please check with your dealer feature availability.

MONSTER

Ducati Red



Aviator Grey



Dark Stealth



MONSTER⁺

Ducati Red



Aviator Grey



Dark Stealth



CUSTOMISATION KITS

More unique than ever

Monster has always been synonymous with personality. And the new Monster makes it even easier for the rider to express this with new customisation kits, comprising decals (decal kit) or painted plastic parts (cover kit). Simply choose from among the many combinations available.

Pixel cover kit



GP cover kit



CUSTOMISATION KITS

Corse decal kit



Logo decal kit



ACCESSORIES

Monster, as you like it

The Monster strength lies in its diversity. In addition to the customisation kits, which can help define the look of your Monster, you can also make use of a wide range of accessories to adapt the Monster to your needs and personality. Push your performance to the max with Ducati Performance accessories. Perfect your style with refined details and quality finishes. The Monster is as unique as you are.



Try the online configurator and customise your new Ducati bike at configurator.ducati.com



1. Silencers. OK EU5



2. Pixel customisation kit Aluminium rear-view mirrors OK A Licence plate holder kit OK A



3_ LH aluminium rear-view mirror. OK A 4_ Brake fluid reservoir. A

5_ Billet aluminium water pump cover. A

6_ Portatarga in alluminio sotto-sella. OK 7_ Billet aluminium footpegs. OK



9_ Sport Headlight Fairing. ■ ■ ■ 10_ Billet aluminium handlebar balancing weights. A ■ ■



11_ Oil filler plug. ■ ■ 12_ Engine belly fairing. ■ ■ ■



APPAREL

Monster, as you wear it

Comfortable yet anything but ordinary. Elegant but also sporty. Much more than a simple clothing collection, Monster apparel is a statement of style and personality, to be flaunted on the road, on track and in everyday life.

1_ Outdoor C-2 Fabric jacket. Downtown C1 Technical short boots.

Ducati Apparel Collection designed by **Drudi Performance**





2

2_ Peak V5 Full-face helmet



3



4

3_ Peak V5 Speed Evo C1 Leather jacket. 4_ Logo C1 Leather gloves.



5

From the top left. DC Track T-shirt. 77 T-shirt. DC Track Short-sleeved polo shirt. D-Stripes Short-sleeved polo shirt. DC Track T-shirt. Game On T-shirt. Heart Beat T-shirt. Racing Spirit T-shirt. Ducatiana 2.0 T-shirt.



6_ Racing Spirit Cap. Acapulco Sunglasses. DC Tonal T-shirt.



7



8



9



10





7_ DC Track Cap. Dovizioso Sunglasses. V4 Eyes T-shirt.

8_ From left. Dovizioso Sunglasses. DC Track T-shirt. Racing Spirit Cap. Acapulco Sunglasses. DC Tonal T-shirt. Racing Spirit T-shirt. 9_ From left. Racing Spirit Cap. DC Track T-shirt. Reflex Flex Cap. Heart Beat T-shirt. DC Track Cap. Racing Spirit T-shirt. Company 2.0. Cap. 77 T-shirt. 10_ DC Track Short-sleeved polo shirt.

Ducati Digital Experience

A mission for every channel. Continuous updating on the innovation and passion for which our work stands out. We transform emotions into exclusive content. Just a click away.



Style, Sophistication, Performance, Trust.
On the asphalt, as on the web. Follow us on:

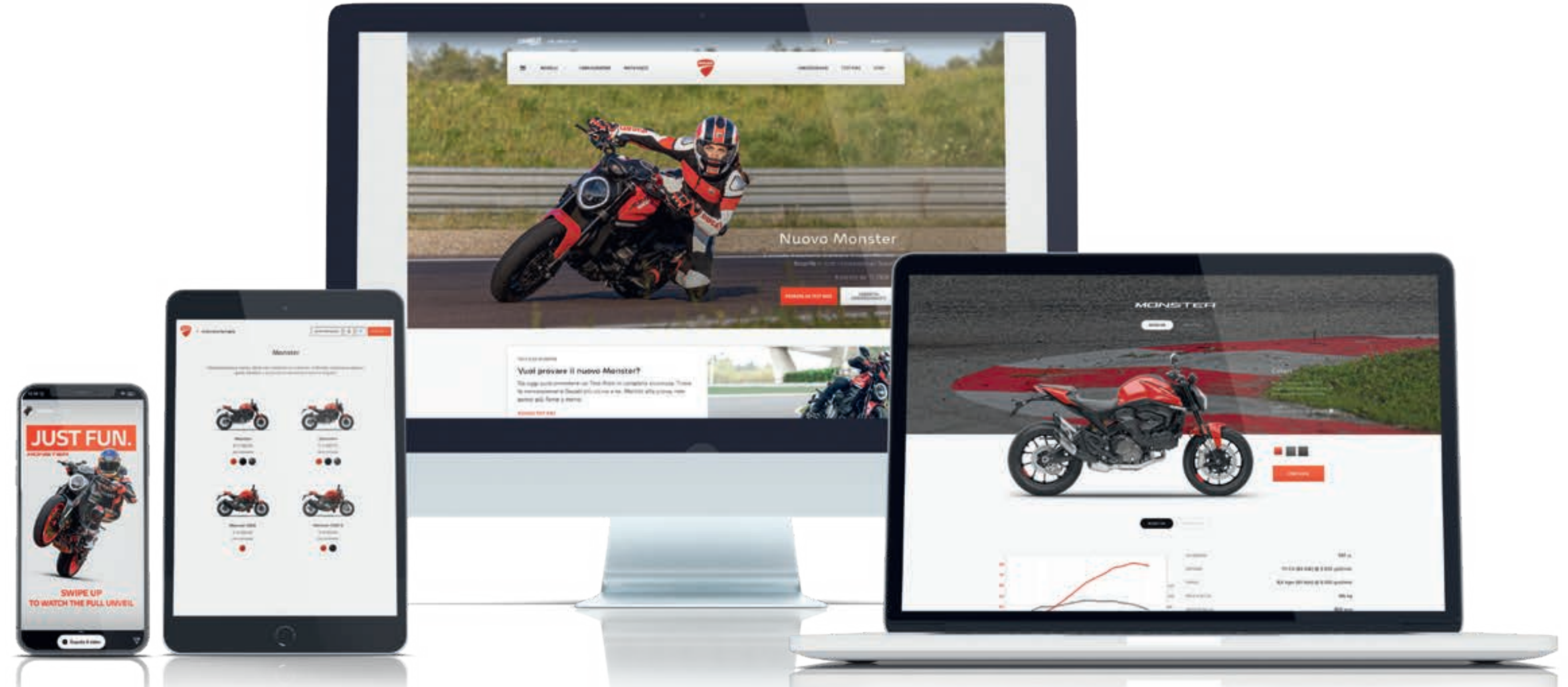

-  @ducati
-  @DucatiMotor
-  Ducati Motor Holding
-  @ducati
-  Ducati Motor Holding





Key to symbols

-  This product is designed exclusively for race bikes ridden on a closed racetrack. Its use on public roads is forbidden by law.
-  This accessory is not approved for road circulation.
-  For racing use only. The product marked with this symbol can only be used on competition vehicles. Use outside a competition track of motorcycles equipped with this product is prohibited by law. Verify any further restrictions with the relevant race course. Motorcycles equipped with this accessory are prohibited from operating on public roads.

-  Anodized
-  Matt
-  Red
-  Black
-  Silver

Riding a motorcycle is the most exciting way to enjoy the road, and offering the utmost safety to the motorcyclist is Ducati's commitment. Ducati bikes are increasingly easy to handle, reliable and better equipped to guarantee maximum safety and enhance riding pleasure. Technical clothing is made with more and more advanced materials for adequate protection and increased visibility. The safety of motorcyclists is Ducati's commitment. For more information visit the safety section of the Ducati site (www.ducati.com).

WARNING: The photos and technical information in this catalogue may refer to prototypes subject to modifications during production and are purely for illustration and reference purposes, and are therefore not binding on Ducati Motor Holding S.p.A. Sole Shareholder Company - Company subject to the direction and coordination of AUDI AG ("Ducati"). Ducati cannot be held responsible for any print and/or translation errors. This catalogue is transnational and therefore some products may not be available and/or their features may vary in accordance with local laws. Not all colours and versions are available in each country. Ducati reserves the right to make changes and improvements to any product without obligation of prior notice or to make such changes to products already sold. Further characteristics of the products

are contained in the pertinent owner's manuals. The products represented are not definitive versions and are therefore subject to significant changes at Ducati's discretion without prior notice. The photographs published in this catalogue show only professional riders under controlled street conditions. Do not attempt to imitate such riding behaviour as it could be dangerous for you or other people on the road. This catalogue, including but not limited to the trademarks, logos, texts, images, graphics and table of contents herein, constitute Ducati intellectual property, or in any event Ducati has the right to reproduce it; any reproduction, modification or other whole or partial use of the catalogue or its contents, including publication on the Internet without the prior written consent of Ducati, is prohibited.

Actual fuel consumption may vary based on many factors, including but not limited to riding style, maintenance performed, weather conditions, surface characteristics, tyre pressure, load, weight of the rider and the passenger, accessories.

Ducati indicates the dry weight of the motorcycle excluding battery, lubricants and coolants for liquid-cooled models. The weights in running order are considered with all operating fluids, standard equipment and the fuel tank filled to 90% of its useful capacity (UE regulation no. 168/2013). For more information visit www.ducati.com.

June 2021.



ducati.com

Developed with 

Technical partner 